

# Service interaction design: A Hawk-Dove game based approach to managing customer expectations for oligopoly service providers

Yen-Hao Hsieh · Soe-Tsyur Yuan · Hsiao-Chen Liu

© The Author(s) 2012. This article is published with open access at Springerlink.com

**Abstract** In the “experience economy”, effectively delivering memorable and exciting customer experiences has become a key issue for service providers. Service experience delivery involves service encounters through which interactions between service providers and customers can be shaped into interactive artifacts managing customer expectations and dynamically delivering suitable services. Service interaction design aims to optimize customer interactions with services to match customer expectations and yield satisfactory service experiences. On the other hand, service providers typically make profits and cost the priority, despite knowing that high service quality can maximize satisfaction, particularly in markets served by an oligopoly, resulting in customers only accepting existing limited-value services. Hence, the oligopoly market can be regarded as a value-bounded context. Additionally, understanding customer expectations regarding a wide range of interactions is crucial to service providers selecting and designing services that match customer expectations. Therefore, this paper presents a service interaction design mechanism to help oligopoly service providers systematically and effectively manage customer expectations in dynamic interactions, even in value-bounded contexts. The proposed

mechanism models this service interaction design problem as a series of Hawk-Dove games that approach an evolutionary stable state. The evaluation results suggest that oligopoly service providers should change their mindsets and design service interactions to manage customer expectations associated with service delivery, not only to ensure high satisfaction and profit but also to engage customers in co-creating value.

**Keywords** Service interaction design · Service experience delivery · Hawk-Dove game · Customer expectation management · Oligopoly service provider

## 1 Introduction

Pine and Gilmore (1999) proposed that the rise of the “experience economy” will become the main determinant of the economic activities of service firms and customer behaviors in the 21st Century. Figure 1 shows the four stages in the evolution of economic value, namely commodities (agrarian), goods (industrial), services (service), and experiences (experience). In the agrarian economy, humans use natural resources (such as water, wheat or vegetables) as commodities to fulfill their basic needs (thirst or hunger). During this stage, economic activity focuses on satisfying customer physiological requirements. In contrast, the experience economy sees businesses provide customers with particular ways to experience services or goods. The economic activities in experience economies not only meet customer physiological needs, but also consider their emotional and psychological experiences. Accordingly, service providers in the experience economy must understand customer needs to provide memorable service experiences, and meeting customer expectations is critical (Meyer and Schwager 2007; Ojasalo 2001; Parasuraman et al. 1991;

---

Y.-H. Hsieh (✉)  
Department of Information Management, Tamkang University,  
New Taipei City, Taiwan  
e-mail: yhhsiehs@mail.tku.edu.tw

S.-T. Yuan · H.-C. Liu  
Department of Management Information Systems,  
National Chengchi University,  
Taipei, Taiwan

S.-T. Yuan  
e-mail: yuans@mis.nccu.edu.tw

H.-C. Liu  
e-mail: joanneliusc@gmail.com

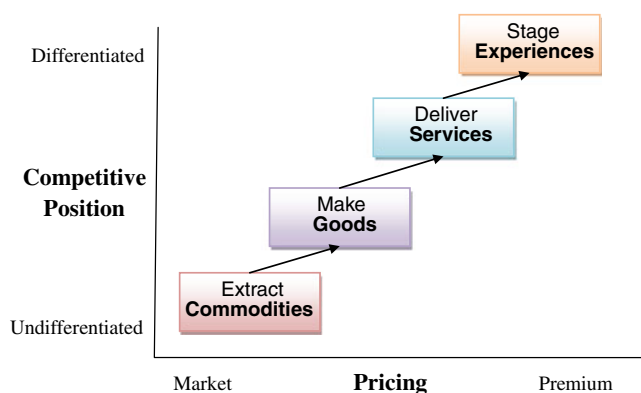

**Fig. 1** The progression of economic value (Pine and Gilmore 1999)

Pine and Gilmore 1999). Managing customer expectations is thus essential to achieving customer satisfaction. Service providers can define and provide competitive services that meet customer expectations to increase market competency (Pitt and Barbara 1994; Schurter and Towers 2006).

Service encounters can be defined as direct interactions between service providers and customers (Lewis and Entwistle 1990). Service experience delivery involves numerous service encounters (Holmlid 2007). This study argues that service experience delivery can be regarded as an interactive artifact that involves process innovation and interactive technology, and that requires responding to customer input and possibly changing customer content or behavior. This study developed an interaction design to influence customer behavior by providing customers with timely and relevant information to enable them to make informed decisions, complete their work easily, or simply be entertained (Saffer 2005). This could be further extended to incorporate services (besides information) delivered to customers. This study claims that interactions between service providers and customers could be shaped into interactive artifacts to manage customer expectations and dynamically deliver suitable services through service encounters. This study terms this kind of interaction design service interaction design. Service interaction design aims to optimize customer interactions with services to match customer expectations and yield satisfactory service experiences.

On the other hand, an oligopoly is a common market structure characterized by imperfect competition. Mergers and alliances resulting from the global division of labor and economic sluggishness have seen numerous industries become oligopolies. For example, the merger of Google and YouTube is a famous case of an oligopoly involving online portal sites. Furthermore, Ingram Micro is the top distributor of information-based products, with many resellers globally (Zhao et al. 2009), and the telecommunications industry can be considered to be an oligopoly, in which a few information service providers (ISPs) dominate the markets for mobile and

network services. Oligopoly markets have fewer sellers than buyers. Oligopoly service providers often dominate customer interactions, and focus on competition rather than customers (Hendricks and McAfee 2000, 2010). Additionally, oligopoly service providers usually lack a long-term perspective on the co-creation of value with customers, and force customers to accept existing services (Hendricks and McAfee 2000, 2010). Hence, an oligopoly market can be considered a value-bounded context.

Customer value is highly restricted in an oligopoly market, since oligopoly service providers may only offer customers limited services and resources. However, oligopoly service providers are often highly competent in delivering positive service experiences (Ren 2007). Such service providers consider costs and profits over customer satisfaction, despite customers expressing numerous needs and making multiple requests regarding service experiences (for example in response to the limited range of services available to them). However, oligopoly service providers can increase customer satisfaction and attract more customers to use their services through effectively managing customer expectations, increasing their market share and thus profits. Restated, to maintain a leading position in an oligopoly market, oligopoly service providers can still manage customer expectations to maintain a good image in the minds of their customers, even in a limited customer value-bounded context.

Restated, oligopoly service providers can provide good experiences and design effective customer interactions by managing customer expectations without significantly impacting revenue. This situation differs from the dilemma where service providers must choose whether to increase services or reduce prices, both of which require considering complex issues like market share and competitors. This study thus examines the following questions:

- Do service interaction design mechanisms exist that oligopoly service providers can adopt to manage customer expectations during a service experience?
- How can oligopoly service providers co-create value with customers in a value-bounded context?

This study develops a service interaction design mechanism for managing customer expectations by providing oligopoly service providers with advice on how to meet customer requirements in service encounters. This work meets the following two objectives. First, it develops a quantitative mechanism to enable service providers to monitor and direct customer interactions during service encounters in a manner that manages customer expectations and ensures customer satisfaction. Second, it conducts simulation experiments to determine the effectiveness and feasibility of applying the proposed mechanism to oligopoly service providers, and to determine the extent of value co-creation in the value-bounded context.

Despite the importance of managing customer expectations, many previous investigations have examined the effect of customer expectations on service satisfaction. These studies used quantitative methods (such as surveys) to gather data from service providers and customers for further analysis. To the best of the knowledge of the authors, few studies have addressed the issue of customer expectation management in relation to service experience delivery, especially in oligopoly markets, by running simulations. However, this study is the first to use the Hawk-Dove game to solve the research problems identified above. Researchers have tended not to tackle the specified problems for three reasons. First, customer expectations are mental states, and thus clearly defining the levels of customer expectations and the influences on those expectations is challenging for both researchers and service providers. Second, many factors (service-related operations, employee quality, service encounter design, and so on) influence service provider delivery of service experiences in an oligopolistic market. Researchers and service providers have difficulty defining research boundaries and simulation parameters to capture practical service experience delivery in such a market. Finally, for the above reasons, constructing a service interaction design mechanism to understand customer expectations and help deliver dynamically appropriate services in real-time service contexts is difficult. Therefore, despite many difficulties in addressing the above research problems and issues, this study proposes both solutions and approaches to overcome these obstacles.

The proposed service interaction design mechanism is based on Hawk-Dove game theory. In an oligopolistic market, competition between providers and customers can be regarded as dynamic (Tan 2006). Both customers and providers seek benefits, namely satisfaction with the service experience and maximized revenue, respectively. The situation is one of conflict, and is considered a non-zero-sum game in which customers and providers can adopt strategies based on cooperation or resistance. As indicated above, an oligopolistic market is a value-bounded context in which both service providers and customers utilize limited resources to increase values and improve the service experience (Durham, 2004). To optimize the management of customer expectations in a value-bounded context, the tension between customer satisfaction and cost to service providers should be coordinated to achieve ecosystem equilibrium (given that both customers and service providers have limited resources to improve the service process and increase customer value). This struggle resembles that of animals competing for resources. The Hawk-Dove game can thus simulate both customers and service providers to identify the optimal evolutionarily stable solutions (Berninghaus and Ehrhart 2003). Restated, both service providers and customers can effectively use the Hawk-Dove game to plan resource investments and optimize customer satisfaction.

The remainder of this paper is organized as follows. Section 2 summarizes the literature on customer expectations and the Hawk-Dove game. Section 3 then presents the logic for designing a system for managing customer expectations and the service interaction design mechanism for the Hawk-Dove game. Section 4 performs experiments to validate the proposed mechanism. Section 5 then discusses contributions to the service interaction design and service experience delivery. Finally, Section 6 discusses the findings and their theoretical and practical implications, and also suggests future research directions.

## 2 Background and related work

Customer expectation management is a central concept in the proposed interaction design mechanism. Service providers designing interactive encounters develop innovative services for customers. This study helps oligopoly service providers manage customer expectations using the Hawk-Dove game during service experience delivery to increase customer satisfaction and profits. This section thus discusses and analyzes the importance of customer expectations and introduces the Hawk-Dove game-based approach.

### 2.1 Customer expectation

A dual-level (desired and adequate levels), dynamic model of customer expectations provides the optimal method for characterizing customer expectations (Parasuraman et al. 1991). The desired and adequate expectation levels represent the service levels that the customer hopes for, and those that are acceptable, respectively. The desired level combines what the customer believes the product “can be” with what they believe it “should be”. The adequate level is partially based on the customer predicted service level. The tolerance zone varies among customers, and even among situations for a single customer. Initial customer expectations are related to expectation disconfirmation, the degree of which influences customer satisfaction. Zeithaml et al. (1993) presented a conceptual framework for specifying service expectations and elucidated customer expectations using 11 antecedent factors (transitory service intensifiers, perceived service alternatives, customer self-perceived service role, situational factors, predicted service, enduring service intensifiers, personal needs, transitory service intensifiers, perceived service alternatives, customer self-perceived service role, situational factors and predicted service), which directly and indirectly affect desired and adequate expectations (as listed in Fig. 2) (Zeithaml et al. 1993). For example, when an automobile provider produces advertisements or contracts that explicitly promise customers it will provide perfect maintenance service, customer expectations increase

**Fig. 2** The nature and determinants of customer expectations of service (Zeithaml et al. 1993)

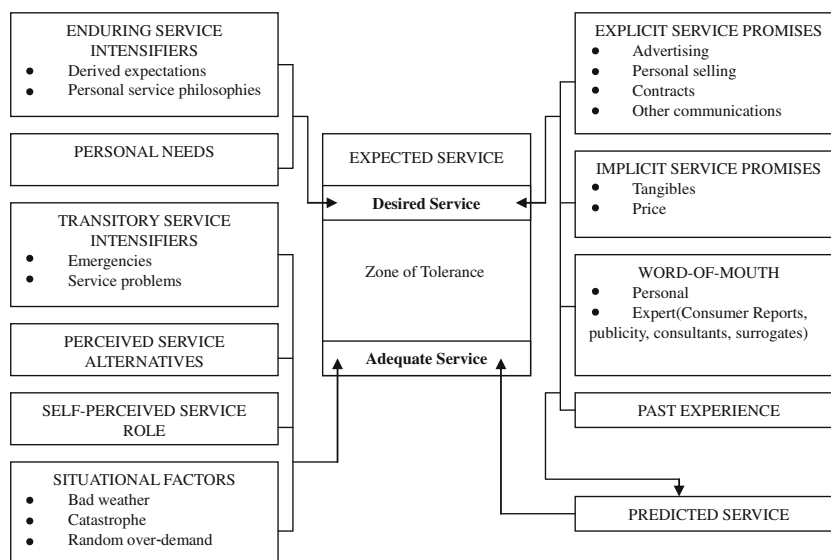

accordingly. Perceived service alternatives are considered, for example: if customers can choose alternative service providers or services, then their levels of adequate service may increase highly. Accordingly, this work uses these determinants of expectation to define service components and thus manage customer expectations.

Understanding customer expectations requires service providers to successfully reach the customer franchise (Parasuraman et al. 1991; Kurtz and Clow 1993; Rust et al. 1999; Haeckel et al. 2003). The conceptualization of multiple expectations influences service provider allocation of resources (Walker and Baker 2000). Service providers can fulfill customer expectations and achieve customer satisfaction if they deliver services in a manner that considers the determinants of expectation. Understanding customer tolerance zone is crucial to ensuring customer satisfaction (Johnston 1995). Managing customer expectations is therefore incorporated into the proposed interaction design mechanism, affecting service delivery and ensuring customer satisfaction.

Competent service providers in an oligopoly market can manage customer expectations by raising the adequate expectation (from Adequate to Adequate') and stabilizing the desired expectation to reduce the tolerance zone (as shown in Fig. 3) and thus increase barriers to competition. For example, since Apple uses branding and promotion to raise customer expectations of its product, customers expect the product to be superior to alternatives. Customer loyalty proves that Apple has successfully managed customer

expectations by raising them, and has achieved a special position in the computer systems market.

### 2.2 Hawk-Dove game

In nature, individuals must forage and sometimes fight for food. The Hawk-Dove game represents one application of game theory to animal behavior (Kokko et al. 2006). The game describes the situation in which contestants can select either an aggressive (Hawk) or non-aggressive (Dove) strategy to compete for a collective resource. Hawks use every opportunity to steal or defend food, while Doves never steal or resist food thieves. These two birds thus comprise a polymorphic population. Mathematically, the Hawk-Dove game is a non-zero sum matrix game with the payoff matrix in Table 1, where V denotes the value of the contested resource; C is the cost of an escalated fight (Smith and Parker 1976), and the former is assumed to be less than the latter ( $C > V > 0$ ).

The payoff matrix displays four possible fight situations. In the first case, when Hawk encounters Hawk, the winner obtains a resource of value V while the loser bears the cost of the fight, C, or both participants bear the cost of the fight equally, C/2. In the second case, when Hawk meets Dove, the Hawk monopolizes the entire resource and leaves the Dove with nothing. In the third case, when Dove meets Hawk, the Dove receives no resource. In the fourth and final case, two Doves meet and share the value of the resource with V/2.

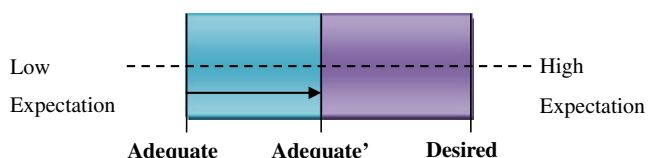

**Fig. 3** The objective of customer expectation management

**Table 1** The basic payoff matrix of Hawk-Dove game

	Hawk	Dove
Hawk	$(\frac{V-C}{2}, \frac{V-C}{2})$	$(V, 0)$
Dove	$(0, V)$	$(\frac{V}{2}, \frac{V}{2})$

The relationship between  $V$  and  $C$  is associated with different population equilibria. Equilibrium refers to the situation when game participants adopt the optimal combination of strategies. By approaching equilibrium, players can optimize resource value. In the aforementioned classic Hawk-Dove game, if  $C > V > 0$ , then the proportion of individuals in the population that adopts the Hawk strategy tends to equal  $V/C$  at equilibrium. (If  $C < V$  the environment favors Hawks, but this factor is not considered here.) Each individual considers value and cost in strategy selection. Strategy selection may eventually approach a stable evolutionary state (ESS). The concept of ESS involves the characteristics of specific Nash equilibriums, which are immune to the invasion of mutant strategies and were developed during the 1970s (Smith and Price 1973). ESS equilibrium has been shown strong enough to attract players who could perform better in other equilibriums, such as the dominated equilibrium (Berninghaus and Ehrhart 2003), particularly when players who are not fully informed of the payoff functions are unaware that they are selecting an ESS.

This study adopts the Hawk-Dove game to simulate the costs incurred, and the value gained, by oligopoly service providers and customers, to examine strategy selection. The evolutionary dynamics associated with consecutive games are considered to be based on repeated interactions between provider and customers in service delivery, and therefore the ESS equilibrium is used to guide strategy selection.

### 3 Hawk-Dove game based interaction design mechanism

This study attempts to design a service interaction design mechanism that oligopoly service providers can use to manage customer expectations in service encounters. The interaction design mechanism is based on the Hawk-Dove game as an analogy for interactions between providers and customers (as described in Section 2.2).

The mechanism comprises five modules of the Hawk-Dove game-based interaction design mechanism, namely the context detection module, the determinant decision module, the Hawk-Dove game module, the expectation measurement module, and the solution selection module (as shown in Fig. 4). In response to customer service requests, the proposed mechanism detects customer behaviors and queries their preferences. The service provider determines the values desired by customers, and considers the circumstances surrounding the selection of the determinants of expectation considered in designing the service interaction. Following determinant selection, the mechanism calculates how to use the determinants in service delivery and uses customer expectations to improve service experiences. Oligopoly service providers thus can adopt the effective service components to achieve satisfactory customer service experiences. The modules are described below.

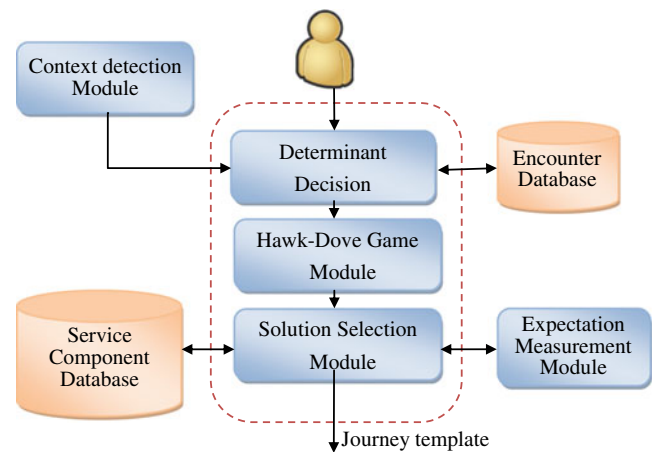

Fig. 4 The Design logic

This study integrated the Hawk-Dove game into an exhibition service system (UESS (Hsieh and Yuan 2009)) characterized by assured delivery of a high quality service experience, enabled by different categories of interaction design mechanisms when interfacing with exhibition stakeholders (visitors, exhibitors and organizers) in a location-based services-enabled exhibition environment. Each class of stakeholder has various goals and can influence the others. The Hawk-Dove interaction design mechanism is activated when the value-bounded context is observed in the presence of oligopolistic exhibitors.

#### 3.1 Context detection module

The context detection module is designed to identify the environment during service delivery. Service operations and resources must be carefully considered to optimize service delivery performance and efficacy. The proposed module must recognize customer feedback and behavior, which can be immediately and accurately inputted to the mechanism to modify the determinant decision module. The learning approach thus is critical to service delivery in a dynamic context.

#### 3.2 Determinant decision module

The determinant decision module uses useful determinants to influence customer expectations based on inputs from the context detection module, customer preferences (such as age, brand interest, price etc.), and data from the encounter database, including previously collected customer data, information regarding delivered services, and so on. This module then automatically analyzes and converts the encounter data, customer preferences and the key performance indicators of the organizer (KPIs) into computable scores to yield the weight of each determinant, indicating the strength of its influence on customer

expectations in the service context. This module selects candidate determinants of expectation that can be adopted to alter customer expectations regarding service delivery. Since this work applies the proposed approach to the exhibition service sector, one domain expert and one researcher with over a decade of experience of this service sector help define a reasonable range for each weighting and parameter.

### 3.3 Hawk-Dove game module

The Hawk-Dove game module determines suitable determinants of expectation for exploitation in service encounters. After the determinant decision module obtains the weight of each candidate determinant of expectation, these determinants are inputted to the Hawk-Dove game module, which thus calculates the effective interaction design for use in service delivery. Figure 5 displays the procedure followed by the Hawk-Dove game module. Based on the input data from the determinant decision module and information on the ESS goal database and customer requirements, the ESS goal identification component can identify goals for customer expectations. Finally, these determinants are inputted to the solution selection module, which is outlined below.

The Hawk-Dove game models a competitive situation involving a shared resource, in which contestants can adopt either an aggressive (Hawk) or passive (Dove) competitive strategy. Mathematically, the Hawk-Dove game is a two-player non-zero sum matrix game (Grundman et al. 2009). This study applies the Hawk-Dove game to design interactions between an oligopolistic service provider and its customers. Either the oligopoly service provider or its customers must attempt to maximize profits while reducing the costs of service delivery. Not only does the oligopoly service provider meet customer needs at relatively high cost, but customers must make more effort to obtain excellent service. From this perspective, each interaction can be regarded as a non-zero sum game.

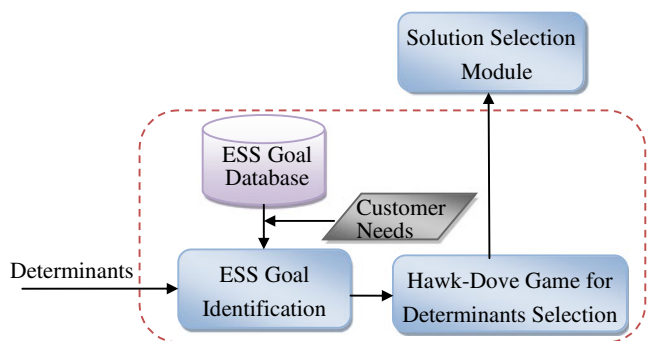

Fig. 5 Hawk-Dove game module

#### 3.3.1 Players

As noted above, experiments involving two main players who can adopt either the Hawk or Dove strategy were performed. Table 2 clarifies both strategies.

#### 3.3.2 Payoff matrix of Hawk-Dove game

The payoff matrix of this Hawk-Dove game of interaction between customers and providers is shown below (as listed in Table 3). When a customer and service provider both select the Dove strategy, the payoff is  $(Coe(p1-c1), V1 + V2)$ . The value  $V1 + V2$  represents the potential benefit to the customer in a service encounter, while the value  $Coe(p1-c1)$  represents the profit to the provider. Table 4 defines the relevant parameters.

As the payoff matrix indicates, a service provider not only evaluates the profit and cost to all stakeholders in a service encounter, but also determines the service arrangement most suited to a customer. Figure 6 displays the payoff in each encounter when a customer and provider select the Hawk and Dove strategies, respectively. The figure also presents the overall profits of the customer and provider, which can be calculated by summing all payoffs in the service encounters.

#### 3.3.3 Environmental parameters

In using the Hawk-Dove game, this work assumes many environmental parameters based on the research of Kokko (Kokko et al. 2006). In each service encounter, customers select the Hawk or Dove strategy at rate  $x$  and the interaction with degree  $\theta$ . Simultaneously, the provider adopts a strategy at rate  $y$ . This interaction gives providers and customers profits of  $\delta_1(P-C)$  and  $\delta_2(V-E)$  respectively. Consequently, the function  $\frac{xy\theta\delta_2}{2}$  denotes the benefit gained by a customer in a single service encounter. For service providers, a similar function  $\frac{xy\theta\delta_1}{2}$  specifies the profit from each service encounter, given that the encounter involves  $n$  customers. The provider can design a series of interactions in various encounters during service experience delivery.

Table 2 The Hawk-Dove strategies considered in our interaction design

Hawk	Providers always propose the service interaction design that cannot accommodate the needs of customer.
Dove	Providers propose the service interaction design that can accommodate the needs of customer.
	Customers always resist taking the service.
	Customers accept the given service arrangement.

**Table 3** The payoff matrix of this Hawk-Dove game

Customer Provider	Dove	Hawk
Dove	(Coe(p1-c1), V1 + V2)	(Coe (p1-c1), V1)
Hawk	(Coe(p2-c2), V1 + V2-E)	(Coe(p2-c2), V1-E)

Both the provider and customer can gain. This study thus uses  $\mu_T$  to represent the gain to the provider and  $\mu_F$  to represent the gain to the customer. Accordingly, the total profit to a provider equals

$$m_T = \mu_T + \frac{xy\theta\delta_1}{2} \tag{1}$$

The total gain by a customer is calculated similarly:

$$m_F = \mu_F + \frac{xy\theta\delta_2}{2} \tag{2}$$

Table 5 lists the definition of each parameter.

### 3.3.4 Evolutionary stable state

In the equilibrium state,  $n$  customers are assumed to be involved in a particular encounter. The oligopoly service provider and customers share limited resources and benefits, as represented by Eq. 3:

$$m_F \times n + m_T = k \tag{3}$$

where  $k$  represents the total gain. The service components are limited since the oligopoly service provider is willing to

**Table 4** The definition of parameters of the payoff matrix

Parameter	Definition
V1	The value generated from the service
V2	The benefit generated when a customer adopts the Dove strategy
p1	The profit generated when a provider adopts the Dove strategy
p2	The profit generated when a provider adopts the Hawk strategy
c1	The cost generated when a provider adopts the Dove strategy
c2	The cost generated when a provider adopts the Hawk strategy
E	The extra effort that the customer pay for the service excellence when the provider play Hawk strategy
Coe	The coefficient indicates one over the number of service providers in the oligopoly market; This study assumes one service provider in the context that <i>Coe</i> is to represent 1

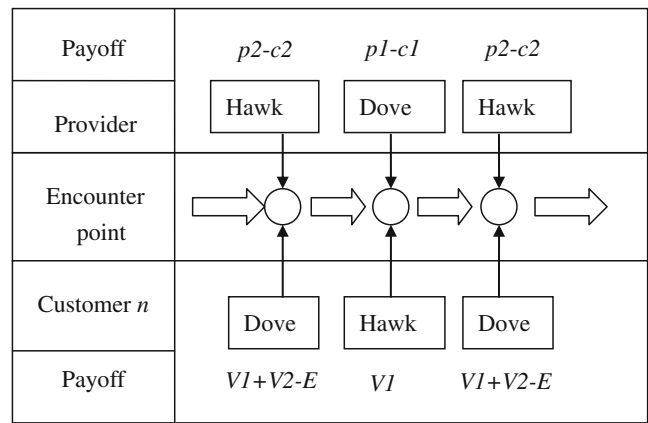

**Fig. 6** The payoff in service encounters

pay a limited cost to supply service components to customers. However, customers can opt out of receiving services from service providers if the receipt of such services requires excessive effort. Accordingly, the service components represent a balance that satisfies both customers and service providers. The limitations on the designed service components (or on the provision of services) set a bound on the profits of the customer and oligopoly service provider. A stable evolutionary state suggests a direction for oligopoly service providers seeking to design interactive service encounters. Oligopoly service providers can set different ESSs to manage expectations to induce customers to seek different values. For example, since oligopoly service providers wish to reduce customization costs, customers can be asked to seek related services themselves.

**Table 5** The model parameters and notation

Symbol	Definition
$m_T$	The total profit of the provider
$\mu_T$	The profit of the service tactics the provider gained in afore-encounters
$x$	The probability of the customer choosing certain action strategy
$y$	The probability of the provider choosing certain action strategy
$n$	The number of customers encountered in a time unit
$\theta$	The degree of customer participating in certain service encounter
$\delta_1$	The rate of providers making profit in certain service solution (P-C)
$m_F$	The total profit of the customer
$\mu_F$	The profit the customer gained in afore-encounters
$\delta_2$	The rate of customer gaining profit in certain service solution (V-E)
$k$	The total profit among customers and providers

The three strategies of the Evolutionarily Stable State are defined by the cost and profit to the provider and customer, as well as by some environmental factors.

- (1) The customer always adopts the Dove strategy, “completely respecting” the service agreement and striving to ensure excellent service.
- (2) The provider always adopts the Dove strategy to accommodate customer needs and expectations.
- (3) In the mixed strategy, the customers “partially respect” the service agreement and sometimes play Hawk to prevent the provider taking their gains, and the provider is forced to fulfill certain customer needs and expectations.

The ESS can supply a provider with direction on the design of service interactions with customers. The provider would set various ESSs as goals in managing the expectations of customers with different values. For example, when a customer wants to control service composition, the service provider may set the goal of the ESS to be the mixed strategy in which the customer is free to select suitable services. In contrast, when the provider asks the customers to find information independently, the service provider reduces the cost of customization while accommodating customer desires with some loss of benefit. This study adopts the mixed strategy (partial respect) for demonstrative purposes.

Figure 7 illustrates the process of designing a service interaction using the Hawk-Dove game. First, the oligopoly service provider utilizes the determinant decision module to determine the combination of determinants of candidate expectation that are relevant to service delivery. Second,

the oligopoly service provider can calculate the costs and profits of both sides to determine whether different determinants can be set to realize the ESS goals of customers at equilibrium. After identifying the proper determinants, the mechanism exploits them in an orderly fashion using the greedy approach, based on the weights derived from user needs and preferences as well as the provider KPI. The greedy approach involves arranging the determinants sequentially from highest to lowest weight. When the Hawk-Dove game selects four determinants for use in service delivery, the greedy approach arranges them sequentially (as shown in Table 6). Figure 8 lists the results for service delivery using the greedy approach. Restated, service providers can deliver required services to customers in each service encounter by analyzing the payoffs to both themselves and customers, and with reference to ESS goals.

### 3.4 Solution selection module

After the Hawk-Dove game module calculates the determinants to be exploited in service delivery, the solution selection module identifies the most suitable service components for managing customer expectations in the value-bounded context. The identification is confirmed by predicting the effects of the chosen determinants using the expectation measurement module, which provides both the scores of the dual expectation measurements and appropriate expectation tactics.

This work assumes that each determinant of expectation is associated with corresponding service tactics (expectation tactics), which are used to select suitable service components, supporting a flexible method for delivering service

**Fig. 7** Exemplar process of the Hawk-Dove game module

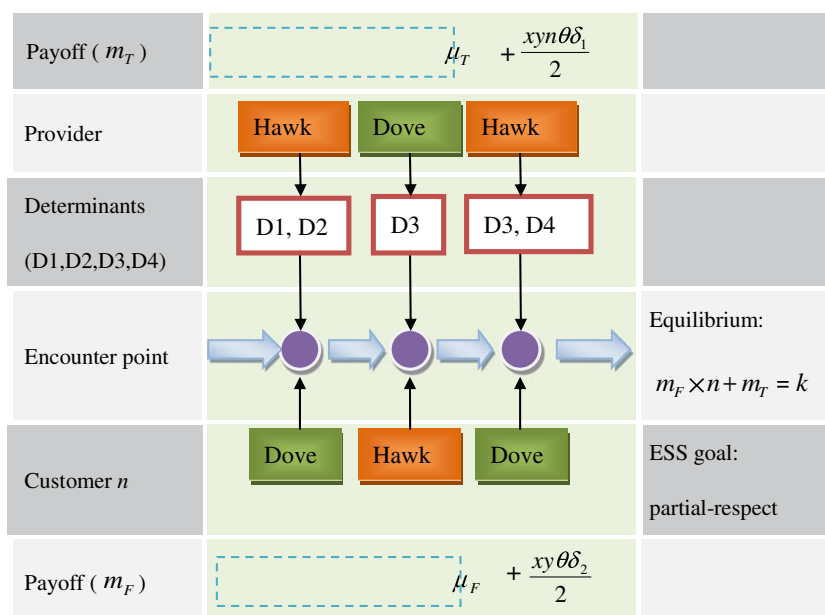



**Table 6** Chosen determinant and determinant weight

Determinant	Determinant weight
Word of mouth	5.2
Explicit service promise	7
Perceived service alternative	3.8
Situation factor	2

components. The recommended product is an example of service tactics used to represent the determinant of expectation, Word-of-Mouth.

The effects of the selected determinants on customer mental state are evaluated to determine the feasibility of employing the expectation measurement module (as detailed in section 3.5). The expectation measurement module can measure customer expectations in real time and in dynamic environments that are affected by the selected determinants.

Based on the chosen expectation tactics, the solution selection module selects service components for implementation. When customers alter their behaviors and service encounter points, the proposed mechanism must interact with customers immediately and dynamically. In this case, the greedy algorithm selects the optimal service components for efficient solution identification. Selecting the optimal combination of service components is a knapsack problem in which the oligopoly service provider must select service components to maximize benefits given a limited budget. The knapsack problem is the following maximization problem.

$$\begin{aligned} & \max \sum_{j=1}^q p_j y_j \\ & s.t. \sum_{j=1}^q c_{0j} y_j \leq c_{0t}, y_j \in \{0, 1\}, j = 1 \dots, q, \end{aligned} \tag{4}$$

where  $q$  denotes the total number of service components, and each service component  $j$  has cost  $c_{0j}$  and profit  $p_j$ . The oligopoly service provider determines the upper bound on the total cost,  $c_{0t}$ , which is the sum of the costs of labor, technology and materials. This module sets the values of  $y_j$  at  $y_j=1$  if the knapsack contains service component  $j$  and at  $y_j=0$  otherwise. The greedy strategy selects the alternative with a maximum  $p_j/c_{0j}$  that fits into the knapsack.

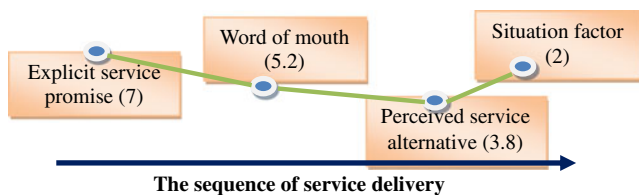

**Fig. 8** The determinants exercised in accord with the greedy approach

The service components identified by the greedy strategy may not be optimal for all implementations, but represent the best combination that the oligopoly service provider can identify given time constraints. Since all service components are allocated by customers and service providers, the oligopoly service provider can estimate costs and profits for each service component during the first stage of service component design. For example, when the oligopoly service provider adopts advertising, it can evaluate the cost and the effect of different advertisements (such as a commercial video or customer mail-outs). Following service component selection, this module considers the context factors (such as the distance between booths or how crowded each booth is, and uses this to arrange the encounters in order) to generate a service delivery template. After the service components are exploited in service delivery, the information obtained by the oligopoly service providers and customers (benefit and cost) is retrieved and fed back to the Hawk-Dove game module.

### 3.5 Expectation measurement module

The expectation measurement module measures the likely performance of the selected determinants identified by the selection solution module by calculating the customer expectation scores. This process helps the solution selection model choose appropriate service components. The expectation measurement module is critical to determining customer mental state (Hsieh and Yuan 2010), and ensuring the integrity and effectiveness of the Hawk-Dove game-based interaction design mechanism. Owing to space limitations, the measurement model is not described in detail here.

The outputs of the expectations measurement model include the adequate expectation score, desired expectation score and a list of recommended expectation tactics. Once the oligopoly service provider determines actual customer expectations based on these outputs, it can propose suitable services to help customers achieve their business goals. Furthermore, the list of expectation tactics, derived from a real-time database, provides a reference. This list of appropriate expectation tactics can be mapped to specific service components to affect customer expectations via the solution selection module. After implementing the expectation tactics (service components), the solution selection module should store (the values of expectation variations and information of providers' capabilities in a real-time database. The expectation measurement model can then use feedback control to reflect actual customer expectations.

### 3.6 Summary

The Hawk-Dove game-based interaction design mechanism is applied to enable oligopoly service providers to deliver

services that ensure customer satisfaction by managing expectations. Initially, needs and preferences are specified to identify customer values, and enable service providers to design and deliver effective services during service experience delivery. Customer expectations determine customer satisfaction during service delivery in a dynamic context. This study applies an innovative method for enriching customer experiences that considers customer mental state. This work also utilizes animal behavior to mimic service interactions between customers and providers. After selecting the determinants of expectation, a greedy algorithm is adopted to choose appropriate low cost and high efficiency service components to enable customers to build a high performance eco-system. Therefore, the Hawk-Dove game-based interaction design mechanism can be considered a substantial and theoretical interface design artifact, comprising five core modules and using customer expectation management to answer the research questions. The following section tests the novel mechanism using experimental simulations.

## 4 Experiments and results

Design assessment is a key step in demonstrating the utility, efficiency, and quality of a designed artifact using well defined evaluation methods (Hevner et al. 2004). The experimental method is a design evaluation method used to examine the designed artifact. This work tests the performance of the Hawk-Dove game-based interaction design mechanism by conducting four sets of experiments (for checking the convergence of the mechanism, evaluating performance in managing customer expectations, measuring customer satisfaction, and evaluating mechanism performance in terms of total payoff).

### 4.1 Experiments for the mechanism's convergence check

The first set of experiments studies the number of iterations in each simulation of the use of determinants of expectation. When the number of iterations exceeds the threshold, the mechanism identifies the determinant of expectation as impractical. This set of experiments determines the optimal number of iterations for causing the simulation results to converge in a particular direction.

The Hawk-Dove game is designed to achieve an evolutionary balance between the various ecology approaches. In the exhibition scenario, equilibrium is defined as total customer profit for the scenario involving a stable oligopoly service provider. Customer reactions to the service context are important in designing effective customer encounter interactions. The total payoff for customers and the oligopoly service provider, and the strategies available for adoption by

customers, thus are considered indicators of game stability. The experiments involve randomly setting game conditions (such as payoff) in various games. This work simulates ten games to examine the number of iterations within which most games reach equilibrium. At the beginning of each game, roughly half of all customers use the Dove strategy, while the remainder are assigned to the Hawk strategy. This experiment thus defines ten games that 1000 customers and one oligopoly service provider must adopt within 50 iterations. Table 7 indicates the detailed parameter settings.

In Fig. 9, the Y axis represents the percentage of customers adopting the Hawk and Dove strategies and the X axis represents the number of iterations. Customer strategies (in ten games – including game1, game2 and so on) may change significantly during the first ten iterations and then gradually evolve toward a single strategy. Consequently, a specific strategy is best suited to each game, each with its own conditions. The total payoffs to the customer and oligopoly service provider also change, as shown in Fig. 10. However, when the payoff from one strategy clearly exceeds that from the other, and when the behavior of the oligopoly service provider changes in response to learning, further iterations may be required to achieve ecological stability of both customers and oligopoly service provider agents. As shown in Fig. 10, most games cease to evolve after an average of ten iterations, and all converge within no more than 40 iterations.

To efficiently simulate the exhibition context and the behavior of customers and oligopoly service providers, this experiment attempts to optimize the number of iterations in the game simulation to minimize resource wastage in the remaining game runs. From the experimental results, 10 ~ 40 iterations can be used as the default number of iterations in subsequent Hawk-Dove game simulation experiments.

### 4.2 Experiments related to managing customer expectations

The Hawk-Dove game-based interaction is developed to manage customer expectations with reference to the objectives of oligopolistic service providers. Since customer expectations vary in dynamic environments, customer stereotypes and their preferences should be considered. The

**Table 7** The parameter settings

Item	Value
Number of service provider agents	1 (oligopoly)
Number of customer agents	1000
Number of games (strategies)	10
Number of simulation iterations	50

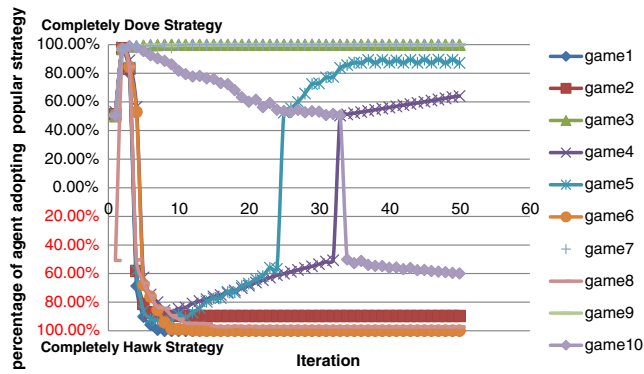

Fig. 9 The strategy most customers adopt at each iteration

second experiment aims to analyze and manage customer expectations to refine the interaction mechanism by clarifying different customer stereotypes and their preferences. Accordingly, this experiment verifies that the Hawk-Dove game-based interaction design mechanism is an effective means of managing customer expectations and identifying customer stereotypes. Expectation management is designed to help oligopoly service providers increase their expectations of what is adequate and stabilize their expectations of what is desirable. Consequently, the zone of tolerance determined by the level of desired expectation is narrowed. This experiment exploits this mechanism to examine the effects of different customer stereotypes on customer expectations.

Five factors (including arrival, capability, effort, request, and subjective preference) influence customer behavior (Frei 2006). Table 8 lists various customer stereotypes. Stereotype 1 involves moderate effort; stereotype 2 makes a serious effort to bargain with the oligopoly service provider, and stereotype 3, which is the opposite of stereotype 1, involves little effort.

This experiment not only employs the above three stereotypes to demonstrate how the Hawk-Dove game-based interaction design mechanism can be used to manage customer expectations in service encounters, but also compares the measured adequate and desired expectations of

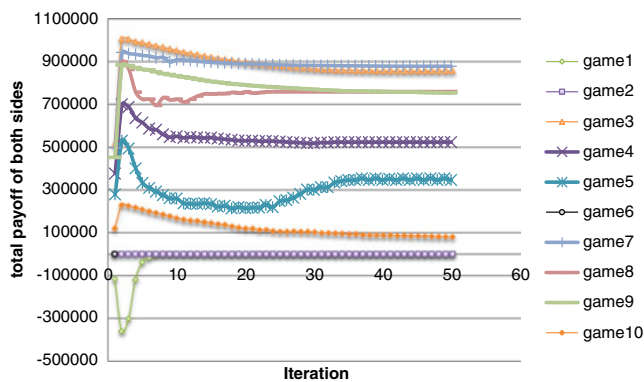

Fig. 10 The total payoff of both sides at each iteration

Table 8 Three customer stereotypes of variability

Customers Stereotypes Indicators	Stereotype 1	Stereotype 2	Stereotype 3
Arrival	often	seldom	seldom
Capability	high	medium	low
Effort	medium	much	a little
Request	growth	relation	existence
Subjective preference	medium, low	medium, low	high, medium

each customer stereotype. For simplicity, this work assumes that all customers have the same initial scores associated with expectation states (where 3.5 means the adequate expectation while 7 indicates the desired expectation). The Hawk-Dove game-based interaction design mechanism organizes ten service encounters for each customer and uses the appropriate determinants in each encounter (as listed in Table 9). Each experiment involves three users of each stereotype to simulate and record the changing expectations associated with each encounter in ten runs. The results in Figs. 11–12 are obtained by averaging the variations in user expectations for a particular stereotype.

Figure 11 demonstrates that the adequate expectation of stereotype 1 increases with number of encounters. For stereotypes 2 and 3, the mechanism slightly increases adequate expectations. Regarding stabilization of desired expectations, Fig. 12 also shows that customer expectations are stable for each customer stereotype. Furthermore, with respect to the goals of increasing the level of adequate expectation and stabilizing the desired level, the experimental results indicate that the mechanism was successful, particularly for stereotype 1.

Stereotype 1 is frequently considered to represent the target customers of the oligopoly market, who are generally able to independently select the best service type since they have requisite domain knowledge (Kuusisto 2008; Rowley 1996). Stereotype 1 can also make more effort to become involved in service experience delivery (Kuusisto 2008; Rowley 1996). When stereotype 1 customers lack service choices, they may adopt medium or low expectations. The experimental results

Table 9 The parameter settings

Item	Value
Number of experimented customer stereotypes	3
Number of customers in each stereotype	3
Initial adequate expectation measurement value	3.5
Initial desired expectation measurement value	7
Number of service encounters	10
Number of runs	10

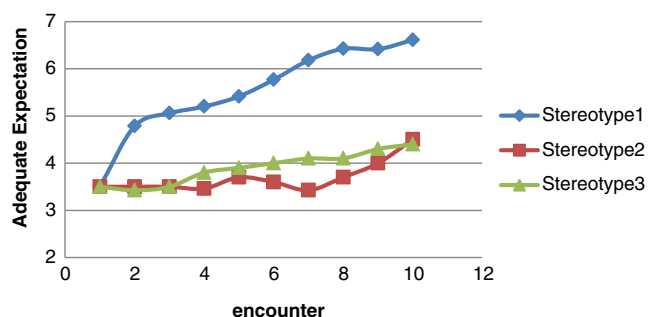

Fig. 11 Adequate level of customer expectation

indicate that oligopoly service providers can provide stereotype 1 customers with the opportunity to reflect on their needs and become involved in service experience delivery using interactions designed specifically to manage expectations. The proposed mechanism can modify the determinants when customer expectations move in the opposite direction to that desired or exceed the expected range. Accordingly, the Hawk-Dove game-based interaction design mechanism not only provides customers with required services, but also reliably manages their expectations.

### 4.3 Experiments for customer satisfaction

The third experiment tests whether the Hawk-Dove game-based interaction design mechanism can deliver services that meet customer needs. The Hawk-Dove game algorithm draws on a fight between a hawk and a dove and is used to simulate interactions between oligopoly service providers and customers. This experiment assesses the effectiveness of the Hawk-Dove game-based interaction design mechanism.

Table 10 shows the payoff matrix of the proposed experiment based on the concepts listed in Table 3. The recommendation determinant denotes the average number of customers who recommend a particular service component to others. A higher recommendation means more customers enjoy and benefit from the service. Regarding the costs of experiencing a service, customers must spend time and effort to use a service component. Accordingly, the customer payoff can be

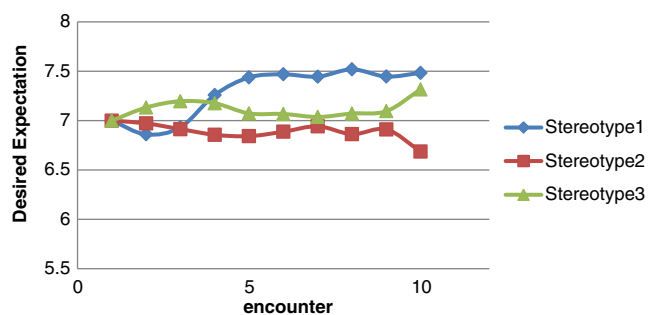

Fig. 12 Desired level of customer expectation

calculated as the determinant profit minus the determinant cost. Furthermore, the payoff of the oligopoly service provider is the benefit of the determinant minus the exercise cost. After interacting with the oligopoly service provider, customer agents can take various steps to increase profits from service encounters, as follows.

- Each agent compares its payoff with those of other agents to confirm the advantage of the selected strategy relative to those of neighboring agents. If the comparison reveals that a different strategy yields a larger benefit, then the agents learn that strategy and adopt it in the next iteration.
- Agents react differently in different simulation runs because they know when their payoff is significantly less than those of the other agents. For example, after an agent implements a service strategy (such as by following the Dove strategy) and compares its payoff with those of other agents, and it sees that it has paid a higher cost than other agents that have used the Hawk strategy in the same service encounter, that agent will reject the service next time around.
- Each agent goes through the processes of interacting and learning to determine when a strategy should be changed. These processes enable agents to maximize profit. Customers that use the Dove strategy are willing to accept the service. The evolutionarily stable strategy balances the strategies of the population. When most agents in the population behave identically, the ecology of the race can be evolutionarily stable, meaning the selected strategy is evolutionarily stable.
- To evaluate the effect of the Hawk-Dove game-based interaction design mechanism on customer satisfaction, this experiment selects appropriate service components for three customers of stereotype 1. In simulating the customer and provider behavior, the Hawk-Dove interaction design mechanism dynamically arranges service components in the visiting journey based on the chosen expectation determinant. Maintaining generality, these experiments used ten encounters in each journey and established seven runs of journey arrangements as listed in Table 11.

These experiments collect the customer satisfaction score for each service component and average these scores for service components arranged in a journey to indicate the degree of customer satisfaction with each journey. The experiments use the degrees of satisfaction of the journey arrangements to evaluate the performance of the service interaction mechanism in examining if the service components dynamically arranged in service encounters are appropriate for customers. In contrast with the effect of the Hawk-Dove game interaction design mechanism, the experiments also conduct an approach in which the service components

**Table 10** The payoff matrix

Customer Provider	Dove	Hawk
Dove	$(\frac{Recommend-Effort+Cost}{3}, \frac{Value-Effort+Costost}{3})$	$(\frac{Recommend-Effort}{2}, \frac{Value-Cost-Effort}{2})$
Hawk	$(\frac{Recommend-Effort-Cost}{2}, \frac{Value-Cost}{2})$	(0,0)

are selected randomly during each service encounter of a journey. In these experiments, the customer reaction as measured by satisfaction score is derived based on analysis of the post-report of AutoTronics Taipei 2009 conducted by the Taiwan External Trade Development Council (TAITRA) which asked visitors to rate their impression for every service component, with the associated scores becoming the basis for assessing the effect of service components.

Figure 13 shows the results of customer satisfaction and every point represents the average degree of satisfaction for each journey of the three visitors. The curves indicate that the degrees of satisfaction for the journeys managed by the Hawk-Dove game based interaction mechanism (around 80 % of customer satisfaction) are higher than when the service components are randomly assigned (around 50 % of customer satisfaction). This indicates that the service components could effectively fulfill customer needs in delivering customer value and services when using the Hawk-Dove game interaction design mechanism.

4.4 Experiments for high performance of the H&D game based interaction design mechanism

This set of experiments is designed to determine how changing visitor expectations increase stakeholder benefits (corresponding to high performance). This set of experiments evaluates the overall performance of the Hawk-Dove game-based interaction design mechanism from a macro perspective. A high-performance ecosystem maximizes benefit to all stakeholders (oligopoly service providers and customers). Surplus value theory (Marx 1952; Carlsson and Davidsson 2002) is used to evaluate ecosystem performance by measuring stakeholder perceptions of value. The equation of surplus value is as follows.

$$S = P - (C + V) \tag{5}$$

where S denotes surplus value; P represents total value; C is total spending on investments and material; V denotes spending on labor, and (C + V) represents total cost. To

**Table 11** The parameters setting

Item	Value
Number of customers	3
Number of journeys	7
Number of encounters	10

model surplus value of an exhibition, the definition of surplus value is extended to include customer and oligopoly service provider value and costs.

This set of experiments uses pareto optimization (Hochman and Rodgers 1969; Sawaragi et al. 1985; Jin and Sendhoff 2008) to evaluate the performance of the Hawk-Dove game-based interaction design mechanism in the target ecosystem. A pareto-optimal outcome is one in which no-one is made better off without making someone else worse off. Customer services are supposed to be pareto-optimal solutions, obtained via the Hawk-Dove game-based interaction design mechanism, that consider various interaction design factors, including profit and cost. The measurement model thus measures the maximum surplus value of all stakeholders achieved using the Hawk-Dove game-based interaction design mechanism with the following objective functions.

$$\begin{aligned} \text{Maximum} : S_p &= P_p - (C + V)_p \\ \text{Maximum} : S_c &= P_c - (C + V)_c \end{aligned} \tag{6}$$

Table 12 lists the definitions of the experimental parameters.  $P_p$  represents the ratio of variation in the quantity of the zone to the original quantity of the zone, and the total cost of implementing service components during the journey is  $(C + V)_p$ . The mechanism represents the customer satisfaction score for all service components experienced in the delivery of a service as  $P_c$ . Finally, the total time spent interacting with every service component in the service encounters is represented by  $(C + V)_c$ . The Hawk-Dove game-based interaction design mechanism arranges 25 customers. The customer satisfaction score for each encounter

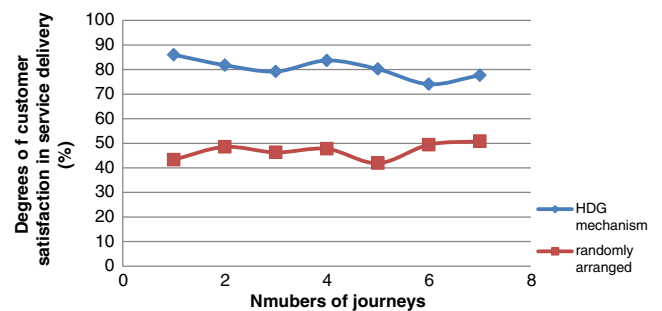

**Fig. 13** Customer satisfaction of each journey

**Table 12** The definitions of parameters in surplus value

Parameter	Definition
$S_p$	Surplus value of service providers
$P_p$	The proportion of variation of the zone of tolerance managed after Hawk-Dove game based interaction design mechanism to the original zone of tolerance $(z-z')/z$
$(C + V)_p$	Providers' participation
$S_c$	Surplus value of customers
$P_c$	Real customers' responses
$(C + V)_c$	Customers' participation

minus the effort made by the customer to interact with a service component is  $S_c$ . The variation in the size of the zone as a proportion of the original *quantity* of the zone minus the cost of implementing all service components is  $S_p$ . Twenty-five customers with randomly assigned  $S_c$  and  $S_p$  are considered to model all possible decisions made by all other possible mechanisms. The random rules are taken primarily from domain experts and practical reports. Comparing these two groups of customers in terms of overall surplus value clarifies the effectiveness of a Hawk-Dove game interaction design mechanism in creating a high-performance eco-system.

Based on the results of the ecosystem evaluation experiment (as shown in Fig. 14), each point represents a visitor. (A red square represents a customer served using the proposed mechanism and a blue rhombus indicates a customer with randomly assigned values of  $S_c$  and  $S_p$ ). Except for a single square point, square points outperform rhombus points. If any points in the rhombus group exhibit quality performance of  $S_p$ , those same points must be associated with poor performance of  $S_c$ . In conclusion, the simulation results clearly indicate that the Hawk-Dove game interaction design mechanism can not only be used to build a well-performing ecosystem but can also benefit customers and providers by providing pareto-optimality.

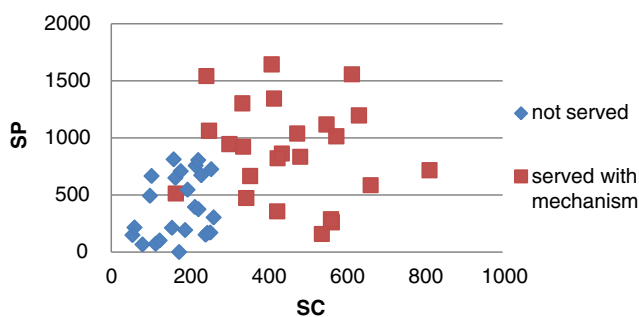

**Fig. 14** Performances of the proposed mechanism in surplus value

### 4.5 Discussion

Service interaction design is important in determining the performance of service experience delivery. This study uses a systematic and quantitative approach, the Hawk and Dove game, to model service interactions between oligopoly service providers and customers where customer expectations are dynamically but systematically managed. Restated, service providers consider customer expectation management during their design of the service interaction aspects of service experience delivery.

Traditionally, service providers have used the survey method (questionnaires) to determine customer expectations, but only after service completion. Understanding customer expectations in real time in service contexts is particularly difficult for service providers who deliver services in real time. This study presents a service interaction mechanism, which involves customer expectations based on elicited service-related requirements and needs. Service providers can thus provide required services based on this information. Customers can choose to receive available services and modify their requirements based on what they receive. Service providers thus can dynamically provide customers with satisfactory services by immediately analyzing customer feedback to clearly understand customer expectations in real-time service contexts. Consequently, both service providers and customers can achieve their goals by participating in interactive service activities.

As indicated above, customers can be grouped into numerous types with different levels of expectation. Service providers can deliver suitable services when they clearly understand customer expectations. For instance, if a service provider knows that a customer has low expectations of frontline services, they can reduce the number of service employees and devote resources to preparing other useful services for the customer. More generally, service providers can dynamically but effectively allocate existing resources to provide customers with more suitable services. Service providers do not need to provide customers with all services, necessarily increasing the cost of service provision. Hence, the proposed service interaction mechanism helps service providers who can flexibly modify their service-related resources provide services that meet customer expectations in a cost-effective manner.

One core feature of S-D logic is the co-creation of value by service providers and customers during service experience delivery. The proposed service interaction mechanism can be considered a platform on which service providers and customers can co-create value. When service providers provide services to customers via the proposed service interaction mechanism, customers can participate in the service activities to improve their own service experience. Customers interact with both service providers and other customers

to share the experiences and knowledge gained during service experience delivery via the proposed service interaction mechanism. Both service providers and customers create value by participating in service activities. Therefore, customer involvement is essential to successful service experience delivery.

Since the proposed service interaction mechanism is designed to be trained and improved by the input of real-world data, the number of training sets and parameters requires careful consideration. In this work, experts on the exhibition industry helped specify suitable training sets and parameters for the experimental simulations. For example, the numbers of training iterations required to ensure the convergence of the HDG method and the customer expectation measurement model are 40 runs and ten runs, respectively. However, since the settings were only imprecisely specified, to imitate the behavior of real-world exhibition visitors, the parameters of the proposed service interaction mechanism must be further tuned by increasing the inputted visitor data. Although continuous learning and searching for suitable parameters in real-time service contexts is necessary, the constraints imposed on service providers by resource limitations and costs are the main factors in terminating training iterations.

## 5 Implications and conclusions

In the experience economy, service providers must design and deliver good customer service based on understanding customer needs. Service providers can increase customer loyalty and thus profits by developing their capacity for experiential design (Pullman and Gross 2004). Interactions involved in service delivery are designed to create functional, purposeful, compelling, and memorable customer experiences (Meyer and Schwager 2007). Additionally, customer involvement can be considered important to the co-creation of value with service providers. In an oligopoly market, while service providers dominate, they must consider customer satisfaction and develop new services. However, businesses face the dilemma of providing additional services to satisfy customers while maintaining high profits (the pursuit of which can risk customer discontent). This predicament becomes serious, particularly in oligopoly markets, which constitute a value-bounded context for customers (owing to the low motivation of oligopoly service providers to invest additional resources in ensuring customer happiness). To resolve this issue in an oligopoly market, this study presents the Hawk-Dove game interaction design mechanism to increase value enjoyed by service providers and customers in a value-bounded context using customer expectation management and service interaction design. This study not only examined the factors that influence customer satisfaction

and the quality of the service experience, but also established a mechanism based on expectation theory and the Hawk-Dove game for delivering a high-quality customer experience.

The Hawk-Dove game-based interaction design mechanism not only efficiently manages customer mental states to maximize customer satisfaction, but also dispatches appropriate services and provides value to customers in a value-bounded context. Based on analysis of the experimental results, the following conclusions can be drawn regarding the Hawk-Dove game-based interaction design mechanism.

Service experience delivery involves service encounters through which interactions between service providers and their customers can be shaped into interactive artifacts managing customer expectations and delivering suitable services. Service interaction design involves optimizing customer interactions with services so they match customer expectations and yield satisfactory service experiences.

- The mechanism can help oligopoly service providers dynamically interact with customers to effectively match customer expectations and ensure satisfactory service experiences, achieving provider business goals in a value-bounded context.
- The mechanism can still deliver satisfactory customer services tailored to various preferences and needs.
- The mechanism can enable oligopoly service providers and customers to co-create value and design a high-performance ecosystem using a theoretical and systematic approach.

The Hawk-Dove game-based interaction design mechanism can alter the managerial perspective of an oligopoly service provider to increase the emphasis on customer mental states and co-create value with customers, rather than merely considering profit in the context of service experience delivery. Oligopoly service providers can consider alternative methods of serving customers based on continuous interaction design.

The experimental results also help oligopoly service providers realize that effective service interactive design can increase both customer satisfaction and profits. Oligopoly service providers must manage limited resources and understand context to deliver appropriate services and ensure customer satisfaction - particularly for stereotype 1 customers. Additionally, oligopoly service providers can also benefit from increased opportunities to involve customers, enabling them to contribute co-creating value. Oligopoly service providers can still significantly improve profits without changing their business methods and service situations. When the proposed mechanism is used to realize effective and interactive service design, oligopoly service providers can attract more customers, increase their market share and improve service ecosystem performance.

However, this work still suffers limitations. For instance, to test the feasibility of the proposed mechanism, many experimental simulations were conducted, but a real field test still needs to be performed to validate the simulation results and establish the mechanism as a practical system. Accordingly, environmental variations and the results of customer feedback should be analyzed to iteratively improve the proposed approach, thus contributing to design science. Additionally, numerous directions for possible future research exist. First, the learning efficiency of the proposed mechanism and ESS recognition mechanism in the Hawk-Dove game requires further improvement. The learning rule could be enhanced by adjusting the mechanism used for neighbor selection and by adding saltant (or mutant) factors to prevent its evolution into an absolute ecological strategy because such an absolute strategy would mean an ecological agent was unable to make strategy adjustment. Second, since the Hawk-Dove game-based interaction design mechanism exploits numerous preference indicators involving the determinants of expectations, it is necessary to define suitable rules to enable consideration of more indicators in selecting appropriate determinants. Finally, future investigations should consider system disturbance. The mechanism can be made to more closely match real-world situations by modifying it to receive immediate user (customer and provider) feedback and reduce information interference

**Open Access** This article is distributed under the terms of the Creative Commons Attribution License which permits any use, distribution, and reproduction in any medium, provided the original author(s) and the source are credited.

## References

- Berninghaus, S. K., & Ehrhart, K. M. (2003). The power of ESS: An experimental study. *Journal of Evolutionary Economics*, 13(2), 161–181.
- Carlsson, B., & Davidsson, P. (2002). Surplus values in information ecosystems. *International Journal of Information Technology and Decision Making*, 1(3), 559–571.
- Durham, Y., McCabe, K., Olson, M. A., Rassenti, S., & Smith, V. (2004). Oligopoly competition in fixed cost environments. *International Journal of Industrial Organization*, 22, 147–162.
- Frei, F. (2006). Breaking the trade-off between efficiency and service. *Harvard Business Review*, 84, 92–101.
- Grundman, S., Komarkova, L., & Rychtar, J. (2009). A Hawk-Dove game in finite kleptoparasitic populations. *Journal of Interdisciplinary Mathematics*, 12, 181–201.
- Haeckel, S. H., Carbone, L. P., & Berry, L. L. (2003). How to lead the customer experience. *Marketing Management*, 12(1), 18–24.
- Hendricks, K., & McAfee, R. P. (2000). A theory of bilateral oligopoly with applications to vertical mergers, mimeo, University of Texas, Austin. <http://www.mcafee.cc/Papers/Bin/Vertical/Concentration.pdf>. Accessed 26 June 2010.
- Hendricks, K., & McAfee, R. P. (2010). A theory of bilateral oligopoly. *Economic Inquiry*, 48(2), 391–414.
- Hevner, A. R., March, S. T., Park, J., & Ram, S. (2004). Design science in information systems research. *MIS Quarterly*, 28(1), 75–105.
- Hochman, H. M., & Rodgers, J. D. (1969). Pareto Optimal Redistribution. *The American Economic Review*, 59(4), 542–557.
- Holmlid, S. (2007). Interaction design and service design: Expanding a comparison of design disciplines. <http://www.nordes.org/data/uploads/papers/143.pdf>. Accessed 9 July 2010.
- Hsieh, Y.H., & Yuan, S.T. (2009). Exquisite technology for service innovation using ubiquitous exhibition service system as example. 2009 INFORMS International Conference on Service Science, August 6–8 2009, Hong Kong.
- Hsieh, Y. H., & Yuan, S. T. (2010). Design of the customer expectation measurement model in dynamic service experience delivery. *Pacific Asia Journal of the Association for Information Systems*, 2(3), 1–19.
- Jin, Y., & Sendhoff, B. (2008). Pareto-based multi-objective machine learning: An overview and case studies. *IEEE Transactions on Systems, Man, and Cybernetics, Part C: Applications and Reviews*, 38(3), 397–415.
- Johnston, R. (1995). The zone of tolerance: Exploring the relationship between service transactions and satisfaction with the overall service. *International Journal of Service Industry Management*, 6(2), 46–61.
- Kokko, H., Lopez-Sepulcre, A., & Morrell, L. J. (2006). From Hawks and Doves to self-consistent games of territorial behavior. *The American Naturalist*, 167(6), 901–912.
- Kurtz, D. L., & Clow, K. E. (1993). Managing Consumer Expectations of Services. *Journal of Marketing Management*, 2(2), 19–25.
- Kuusisto, A. (2008). Customer roles in business service production-implications for involving the customer in service innovation, Lappeenranta University of Technology. [http://akseli.tekes.fi/opencms/opencms/OhjelmaPortaali/ohjelmat/Serve/fi/Dokumenttiarkisto/Viestinta\\_ja\\_aktivointi/Julkaisut/Kuusisto\\_Paeaellysaho\\_raportti.pdf](http://akseli.tekes.fi/opencms/opencms/OhjelmaPortaali/ohjelmat/Serve/fi/Dokumenttiarkisto/Viestinta_ja_aktivointi/Julkaisut/Kuusisto_Paeaellysaho_raportti.pdf). Accessed 18 August 2010.
- Lewis, B., & Entwistle, T. (1990). Managing the service encounter: A focus on the employee. *International Journal of Service Industry Management*, 1(3), 41–52.
- Marx, K. (1952). *Theories of Surplus Value*. New York: International Publishers.
- Meyer, C., & Schwager, A. (2007). Understanding customer experience. *Harvard Business Review*, 85(2), 117–126.
- Ojasalo, J. (2001). Managing customer expectations in professional services. *Managing Service Quality*, 11(3), 200–212.
- Parasuraman, A., Berry, L. L., & Zeithaml, V. A. (1991). Understanding customer expectations of service. *Sloan Management Review*, 32(3), 39–48.
- Pine, B. J., & Gilmore, J. H. (1999). *The Experience Economy*. Boston: Harvard Business School Press.
- Pitt, L. F., & Barbara, J. (1994). Management of customer expectations in service firms: A study and a checklist. *Service Industries Journal*, 14(2), 170–189.
- Pullman, M., & Gross, M. (2004). Ability to experience design elements to elicit emotions and loyalty behaviors. *Decision Sciences*, 35(3), 551–578.
- Ren, F. (2007). Analysis of the double-oligarch's output-competition decisions in relevant region. *Asian Social Science*, 3(5), 45–49.
- Rowley, J. E. (1996). Customer compatibility management: An alternative perspective on student-to-student support in higher education. *International Journal of Educational Management*, 10(4), 15–20.
- Rust, R. T., Inman, J. I., Zahorik, J., & Jia, A. (1999). What you don't know about customer-perceived quality: The role of customer expectation distributions. *Marketing Science*, 18(1), 77–92.
- Saffer, D. (2005). The Role of Metaphor in Interaction Design, Thesis, Carnegie Mellon University, Pittsburgh.
- Sawaragi, Y., Nakayama, H., & Tanino, T. (1985). *Theory of Multi-objective Optimization*. New York: Academic.



- Schurter, T., & Towers, S. (2006). *Customer Expectation Management: Success without Exception*. Florida: Meghan-Kiffer Press.
- Smith, J. M., & Parker, G. A. (1976). The logic of asymmetric contests. *Animal Behavior*, *24*(1), 159–175.
- Smith, J. M., & Price, G. R. (1973). The logic of animal conflict. *Nature*, *246*, 15–18.
- Tan, W. (2006). The effects of taxes and advertising restrictions on the market structure of the U.S. cigarette market. *Review of Industrial Organization*, *28*(3), 231–251.
- Walker, J., & Baker, J. (2000). An exploratory study of a multi-expectation framework for services. *Journal of Service Marketing*, *14*(5), 411–431.
- Zeithaml, V. A., Berry, L. L., & Parasuraman, A. (1993). The nature and determinants of customer expectations of service. *Journal of the Academy of Marketing Science*, *20*, 1–12.
- Zhao, K., Xia, M., Shaw, M. J., & Subramaniam, C. (2009). The sustainability of B2B e-marketplaces: Ownership structure, market competition, and prior buyer-seller connections. *Decision Support Systems*, *47*(2), 105–114.
- Yen-Hao Hsieh** is an Assistant Professor of Department of Information Management in College of Business and Management at Tamkang University in Taiwan. He received his Ph.D. in Management Information Systems from National Chengchi University. His research interests include Service Science, Service Experience Design, Customer Expectation Management.
- Soe-Tsyur Yuan** is the Director of Service Science Research Center and a Professor of Department of Management Information Systems in College of Commerce at National Chengchi University in Taiwan. She received her Ph.D. in Computer Science from Oregon State University in USA. Her research interests include Service Science, Service Design, Intelligent Agents, Data Mining, E/M-Commerce.
- Hsiao-Chen Liu** received her Master degree from Department of Management Information Systems in College of Commerce at National Chengchi University in Taiwan. She currently works in Chunghwa Telecom Company in Taiwan.